

消防炮炮头 DIFFUSERS

直流-开花-喷雾 3种射流模式，硬质阳极氧化铝合金或者不锈钢材质，电控调节射流模式和流量。
Straight stream, attack spray and wide angle spray. In anodised aluminium alloy or stainless steel. Motorised selection of flow pattern and flow rate.

▶ 自动调压炮头 DIFFUSERS WITH AUTOREGULATION



AUTOKADOR 5000 炮头
DIFFUSER AUTOKADOR 5000



AUTOKADOR-不锈钢 3000炮头
DIFFUSER AUTOKADOR INOX 3000

▶ 固定流量炮头 DIFFUSERS WITH FIXED FLOW RATE



POKADOR 2000 炮头
DIFFUSER POKADOR 2000



POKADOR-不锈钢 2000炮头
DIFFUSER POKADOR INOX 2000

▶ 流量和射流模式可调节炮头 DIFFUSERS WITH SELECTABLE FLOW RATE AND FLOW PATTERN



DEBIKADOR 5000 炮头
DIFFUSER DEBIKADOR 5000

接口 COUPLINGS



STORZ



NST



GFR



MACHINO



GOST



DSP



BARCELONA



INSTANTANEOUS

PLA_01080_Flyer CH-EN 电控消防炮_Motorised Monitors

电控消防炮
MOTORISED MONITORS

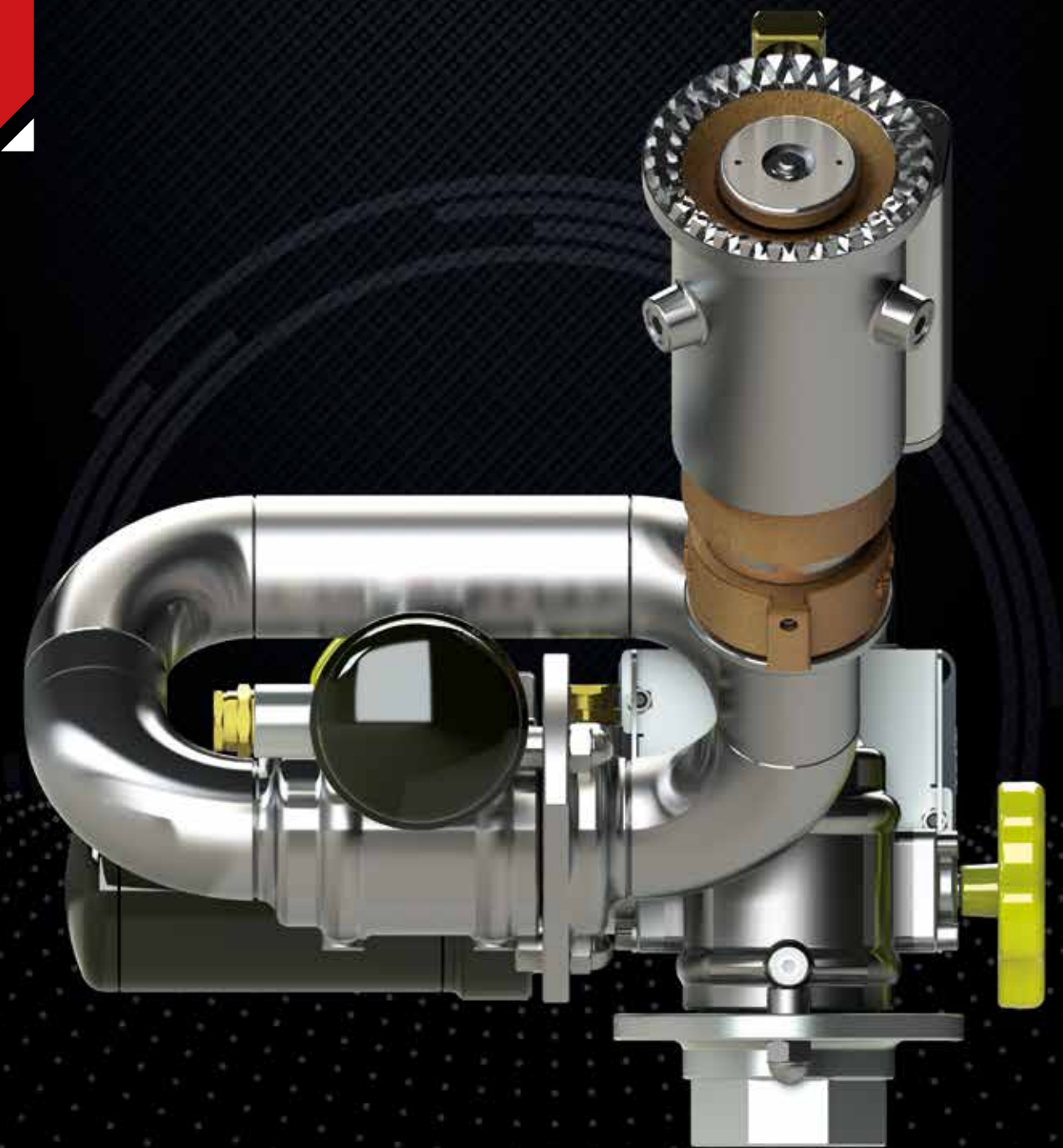

POK CHINA

博克消防装备科技有限公司

地址：北京市顺义区南彩镇彩达三街一号茂华工场5号厂房2层201室·POK

电话：010 64667868

邮箱：info@pokchina.com sales@pokchina.com

www.pokchina.com

充满激情的创造者 / WE CREATE WITH PASSION

遥控系统

REMOTE CONTROL SYSTEMS

从最简单的遥控系统版本（2速），到目前为止市场上最完整的遥控系统版本（5轴向）
 Going from the simplest version (2 speed control) to the more complete (up to 5 axes), the most complete range of remote controls on the market.

MCR – mini迷你遥控系统：直观而简单的操作系统使遥控更精准。
 MCR - Mini Remote Control: intuitive and simple for a better monitoring precision.



- ▶ 无线电自动调频遥控器(16频段)- 433 – 434 MHz
 Radio with automatic frequency synthesiser (16 frequencies) - 433 - 434 MHz
- ▶ 遥控距离：空地150米 / Range of radio transmission: 150 m in free-field
- ▶ 遥控器尺寸(长x宽x高)：155 x 78 x 33 mm
 Dimensions of the transmitter (LxH): 155 x 78 x 33 mm
- ▶ 遥控器重量：280 g 带电池 / Weight of the transmitter: 280 g with battery
- ▶ 接收器尺寸(长x宽x高)：155 x 78 x 33 mm
 Dimensions of the receiver (LxH): 155 x 78 x 33 mm
- ▶ 防水等级：IP66 / Waterproof protection class: IP66
- ▶ 使用温度：-30°C 到 +70°C / Operation temperature: from -30°C to +70°C
- ▶ 遥控功能：垂直仰俯（变速控制）
 Remote-controlled functions: Elevation (proportional control)
- ▶ 水平旋转（变速控制，自摆调节）炮头（开-关控制）- 急停
 Horizontal (proportional control with automatic sweeping option) Diffuser (on-off control) - Emergency stop

FULL V2：最强大的固定消防炮遥控系统，配备多种控制功能。
 FULL V2: the most comprehensive system to control fixed monitors with an extensive number of options.

- ▶ 无线电自动调频遥控器(16频段)- 433 – 434 MHz
 Radio with automatic frequency synthesiser (16 frequencies) - 433 - 434 MHz
- ▶ 遥控距离：300 米空地 / Range of radio transmission: 300 m in free-field
- ▶ 遥控器尺寸(长x宽x高)：170 x 85 x 137 mm
 Dimensions of the transmitter (LxH): 170 x 85 x 137 mm
- ▶ 遥控器重量：1,970 Kg 带电池 / Weight of the transmitter: 1,970 Kg with battery
- ▶ 接收器尺寸(长x宽x高)：224 x 130 x 87 mm
 Dimensions of the receiver (LxH): 224 x 130 x 87 mm
- ▶ 防水等级：IP66 / Waterproof protection class: IP66
- ▶ 使用温度：-30°C 到 +70°C / Operation temperature: from -30°C to +70°C
- ▶ 遥控功能：垂直仰俯（变速控制）- 水平旋转（变速控制，自摆调节）- 炮头（喷射模式控制）- 鸭嘴炮管（直流-发散控制）- 流量调整（大-小控制）- 电动伸缩管（上-下）阀门（开/关）- 急停
 Remote-controlled functions: Elevation (proportional control) - Horizontal (proportional control with automatic sweeping option) - Diffuser (on-off control) - Blabbermouth (on-off control) - Adjustable flow rate (on-off control) - Telescopic tube (up and down) - Valve (open / close) - Emergency stop



TECHNO V2：工业级别遥控系统
 TECHNO V2: THE control panel for industrial installations.

- ▶ 供电电压：230 VAC – 16A – 50 Hz / Power supply: 230 VAC - 16 A - 50 Hz
- ▶ 备用电池（可选）24V – 18 Ah / Spare batteries (optional) 24 V - 18 Ah
- ▶ 操作方式：手动：遥控控制消防炮转动 - 自动：外部数据源开启自摆（热点检测）
 Operation modes: Manual: control of the movements with the remote control - Automatic: automatic sweeping action from external data source (hot spot detection)
- ▶ 通过学习可设置功能：电子限位 - 消防炮攻击档位 - 消防炮存储档位 - 档位显示(选配)
 Configurable functions by learning: Electronic stops - Attack position of the monitor - Parking position of the monitor - Position display (optional)
- ▶ 遥控功能：垂直仰俯(变速控制，自摆调节) 水平旋转(变速控制，自摆调节)
 Remote-controlled functions: Elevation (proportional control with sweeping option) Horizontal (proportional control with automatic sweeping option)
- ▶ 炮头（喷射模式控制）- 阀门（开/关）- 急停
 Valve (open / close) - Emergency stop



DN 65 移动式消防炮 PORTABLE MONITORS

得益于电池和电控系统，该款移动式消防炮可自主投入战斗，流量可达到2400升/分(摇杆渐进控制运转速度)。
 Totally independent thanks to its battery and remote control, transportable, offers a flow rate up to 2400 lpm (gradual movements with the joystick).

- ▶ 入水口：外螺纹 2"1/2 NST-NH / Inlet: male 2.5" NST-NH
- ▶ 水路直径 Ø：65 mm / Waterway Ø: 65 mm
- ▶ 最大工作压力：PN16 / Nominal pressure: PN 16
- ▶ 铝合金 / Material: aluminium alloy
- ▶ 表面处理：聚酯涂层和硬质阳极氧化
 Surface treatment: polyester coating and hard anodisation
- ▶ 水平旋转角度：360°无限旋转 / Horizontal movement: over 360°
- ▶ 水平旋转调整方式：电机驱动和手轮手动
 Horizontal adjustment: motorised and spare handwheel
- ▶ 垂直俯仰角度：+32° 到 +90° / Vertical movement: from +32° to +90°
- ▶ 垂直俯仰调整方式：电机驱动和手轮手动 / Vertical adjustment: motorised and spare handwheel
- ▶ 供电电压：24V DC / Power supply: 24V CC
- ▶ 转动速度：22°/秒 / Speed: 22°/s
- ▶ 安全系统：折叠支架锁止，安全带 / Safety: locking of the legs, anchoring strap
- ▶ 搬运手柄：是 / Carrying handle: YES
- ▶ 可折叠支架：是 / Foldable legs: YES
- ▶ 选配：设备入水口，出水口，控制系统，手推车
 Options: inlet coupling, outlet equipment, control system, trolley

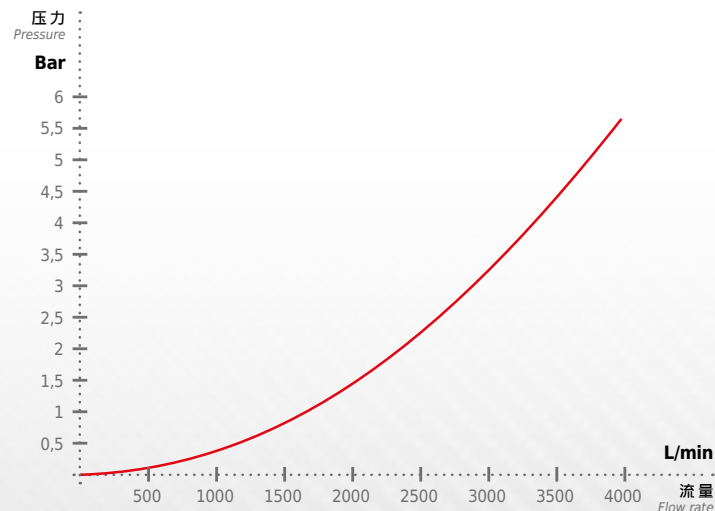

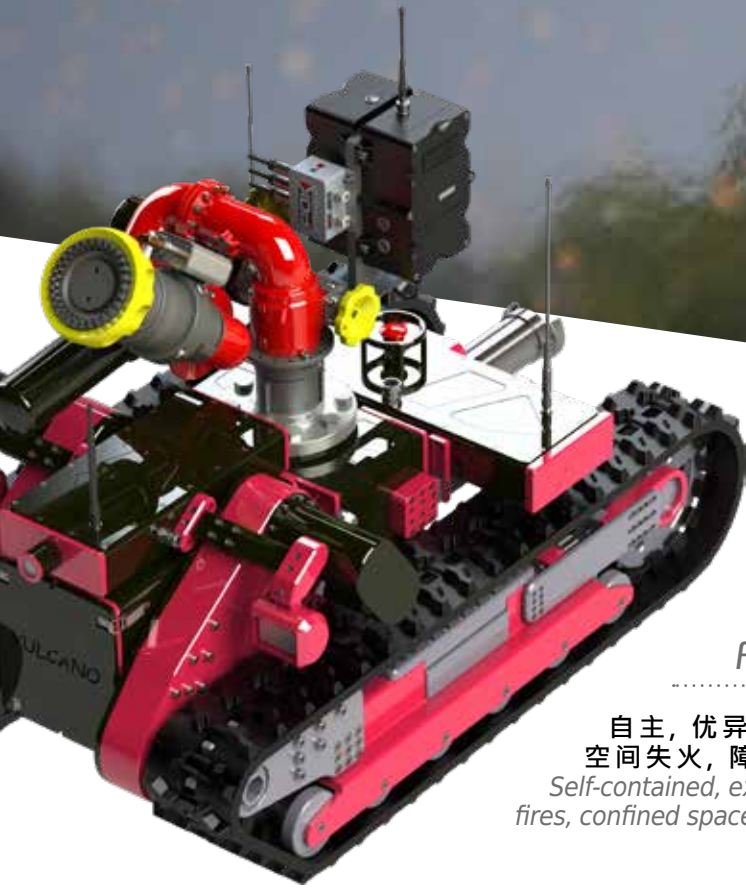

机器人消防炮 固定消防炮 FIXED MONITORS

自主, 优异的通过性能, 隧道火灾, 停车场失火, 密闭空间失火, 障碍受阻环境, 石油石化火灾。
Self-contained, excellent crossing capacity, tunnel fires, parking lot fires, confined spaces, hostile environments.

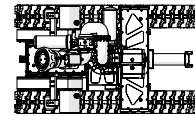

消防炮: LMP65 RC - 产品代码: 26544 / Monitor: LMP65 RC - Ref.: 26544
炮头: Autokador 3000 - 产品代码: 29209
Diffuser: Autokador 3000 - Ref.: 29209
机器人参数 / Robot characteristics
外形尺寸 (长x宽x高): 1230 x 720 x 970 mm
Dimensions (LxWxH): 1230 x 720 x 970 mm
重量: 200 kg / Weight: 200 kg
续航里程: 2/4 小时 / Duration: 2/4 hours
载重: 200 kg / Payload: 200 kg
速度: 4 km/h / Speed: 4 km/h
障碍物通过高度: 20 cm / Obstacle clearance: 20 cm
坡度: 45° / Slope: 45°
侧坡: 35° / Side slope: 35°
防腐处理: 是 / Anticorrosion treatment: Yes
空地遥控驾驶距离: 300 米 / Monitoring distance in free field: 300 meters

选配: 数码视频传输
Options: Numeric video transmission
前摄像头 720p / Front camera 720p
两个LED摄灯 / 2 x Leds projectors
3轴视频旋转 - 可变焦距镜头 x36 (可夜视)
Video turret 3 axis - Camera with zoom x36 (night and day)
热成像摄像机 / Thermographic video camera
传感器: 煤气, 温度, 激光测距
Sensors: gaz, temperature, laser telemeter
备用电池 / Extra battery
双充电器 / Double charger



MONTMIRAIL DC, DN 80 移动式消防炮

PORTABLE MONITORS

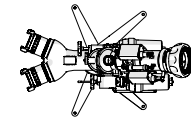

同种类产品中最低的, 轻松搬运, 流量可达到 4000 升/分 (遥控操作)。
The lightest of its kind, easily portable, offers a flow rate up to 4000 lpm (gradual movements with the joystick).

入水口: 2 x 外螺纹 2"1/2 BSP / Inlets: 2 x male 2.5" BSP
水路直径 Ø: 80 mm / Waterway Ø: 80 mm
最大工作压力: PN16 / Nominal pressure: PN16
铝合金 / Material: aluminium alloy
表面处理: 聚酯涂层和硬质阳极氧化
Surface treatment: polyester coating and hard anodisation
水平旋转角度: -180° 到 +180°
Horizontal movement: from -180° to +180°
水平旋转调整方式: 电机驱动和手轮手动
Horizontal adjustment: motorised and spare handwheel
垂直俯仰角度: +25° 到 +85°
Vertical movement: from +25° to +85°
垂直俯仰调整方式: 电机驱动和手轮手动
Vertical adjustment: motorised and spare handwheel
转动速度: 9°/秒 / Speed: 9°/s
供电电压: 24V DC / Power supply: 24V CC
安全系统: 可折叠支架锁止, 安全带
Safety: locking of the legs, anchoring strap
搬运手柄: 是 / Carrying handle: YES
可折叠支架: 是 / Foldable legs: YES
选配: 设备入水口, 出水口, 控制系统
Options: inlet coupling, outlet equipment, control system

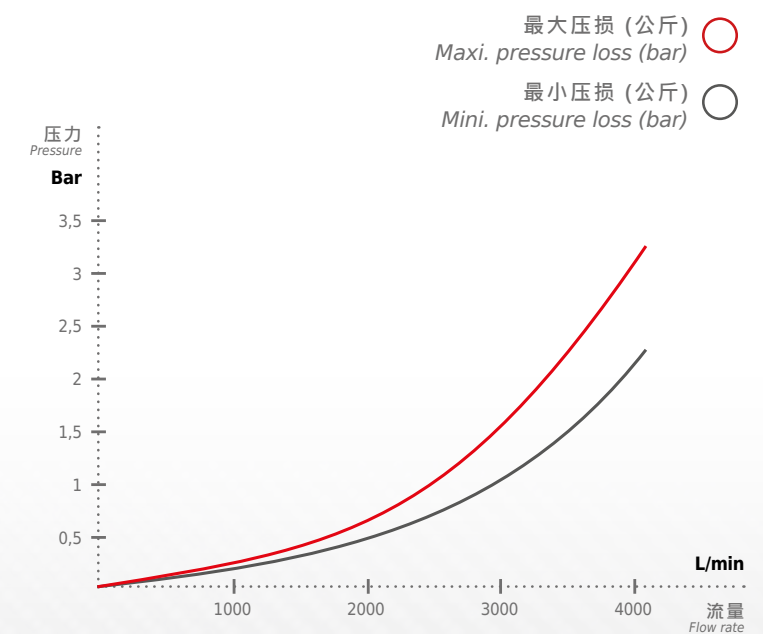
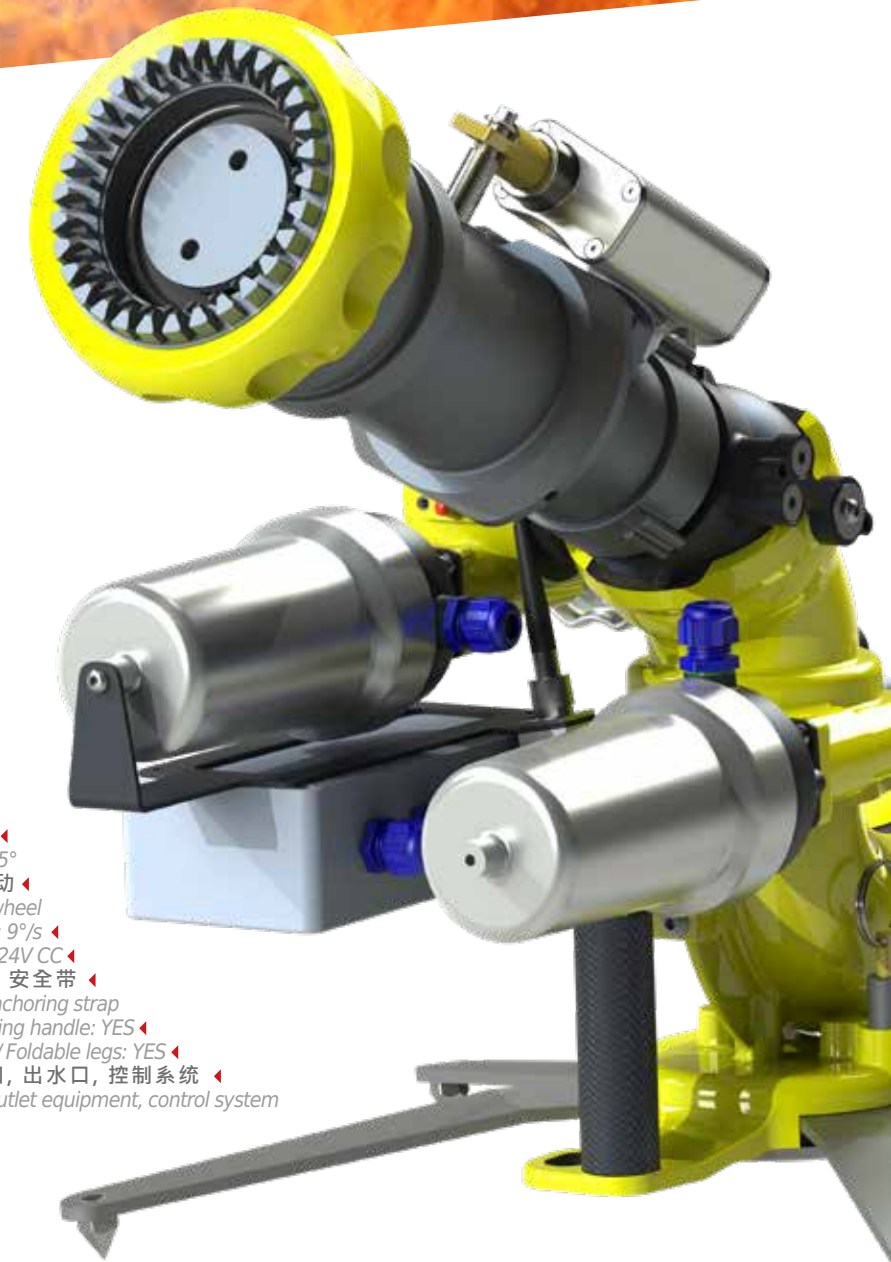



DN 100 固定消防炮 FIXED MONITORS

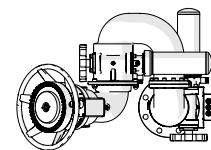

结构紧凑，外廓尺寸最小，遥控，流量可达到7500升/分。
Very compact and entirely remote controlled, it offers a flow rate up to 7500 lpm.

- ▶ 入水口：法兰 4" ASA 150 - PN20 / Inlet: 4" ASA 150 - PN20 flange
- ▶ 水路直径 Ø：100 mm / Waterway Ø: 100 mm
- ▶ 最大工作压力：PN16 / Nominal pressure: PN16
- ▶ 铝合金 / Material: aluminium alloy
- ▶ 表面处理：聚酯涂层和硬质阳极氧化
Surface treatment: polyester coating and hard anodisation
- ▶ 水平旋转角度：360°无限旋转 / Horizontal movement: over 360°
- ▶ 水平旋转调整方式：电机驱动和手轮手动 / Horizontal adjustment: motorised and spare handwheel
- ▶ 垂直俯仰角度：-90 到 +90° / Vertical movement: from -90° to +90°
- ▶ 垂直俯仰调整方式：电机驱动和手轮手动 / Vertical adjustment: motorised and spare handwheel
- ▶ 转动速度：9°/秒 / Speed: 9°/s
- ▶ 供电电压：24V DC / Power supply: 24V CC
- ▶ 选配：入水口法兰，出水口装备（炮头/炮管），控制系统
Options: inlet flange, outlet equipment, control system



DN40, 不锈钢 固定消防炮

FIXED MONITORS, IN STAINLESS STEEL

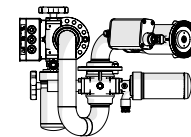

结构紧凑的小流量电控消防炮（1000升/分），
是消防车的理想选择。
For applications that require a small flow rate (1000 lpm),
entirely remote controlled, ideal for vehicles.

- ▶ 入水口：法兰 DN40 PN16 / Inlet: DN40 PN16 flange
- ▶ 水路直径 Ø：40 mm / Waterway Ø: 40 mm
- ▶ 最大工作压力：PN16 / Nominal pressure: PN16
- ▶ 材料：不锈钢 / Material: stainless steel
- ▶ 水平旋转角度：de -170° 到 +170° / Horizontal movement: from -170° to +170°
- ▶ 水平旋转调整方式：电机驱动和手轮手动 / Horizontal adjustment: motorised and spare handwheel
- ▶ 垂直俯仰角度：de -90° 到 +90° / Vertical movement: from -90° to +90°
- ▶ 垂直俯仰调整方式：电机驱动和手轮手动 / Vertical adjustment: motorised and spare handwheel
- ▶ 供电电压：24V CC / Power supply: 24V CC
- ▶ 转动速度：12°/秒 / Speed: 12°/s
- ▶ 选配：入水口法兰，出水口装备（炮头/炮管），控制系统
Options: inlet flange, outlet equipment, control system

